

EL[®]MARK

The Brand of Electricity

SMALL SIZES GARDEN LANTERN ANNA



Technical data:

- Rated voltage: 230V/ 50-60Hz
- Lamp holder: E27
- Colour: Black
- Material:
 - Lantern body: Resin with glass
 - Post lantern body: steel+ resin; Anticorrosion; Not affected by chemical fertilizes
- Insulation class II
- Protection rating IP55

Features:

- Hexagonal lantern in classic style
- Made of shockproof resin material
- UV-rays stabilized, rust and corrosion-free.
- Modular construction suitable for post top, hanging and wall installation.
- Suitable for outdoor use

Variants and Dimensions:

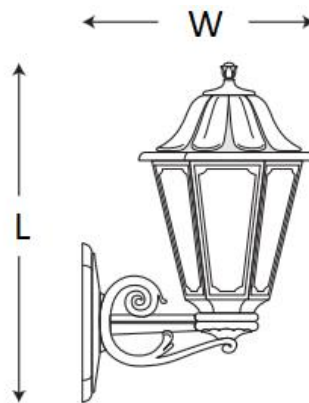

Catalogue number	Model	Lamp included	Colour body	Lamp holder	Size (mm)	
					Length	Width
96120WU/BL	Wall lantern- UP	no	Black	E27	450	275

TECHNICAL SPECIFICATION

GARDEN

ELMARK[®]

The Brand of Electricity

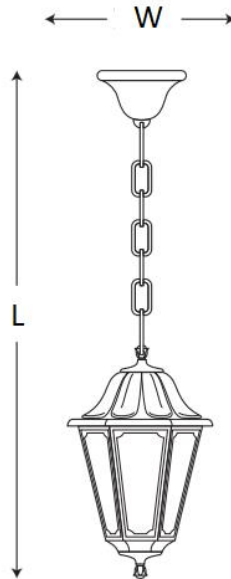

Catalogue number	Model	Lamp included	Colour body	Lamp holder	Size (mm)	
					Length	Width
96120P/BL	Wall lantern- Hanging	no	Black	E27	800	220

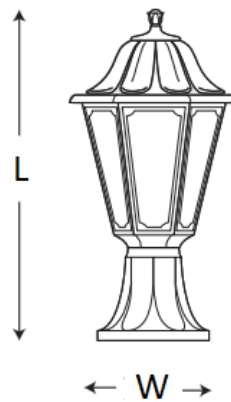

Catalogue number	Model	Lamp included	Colour body	Lamp holder	Size (mm)	
					Length	Width
96120MF/BL	Lantern floor post	no	Black	E27	385	130

TECHNICAL SPECIFICATION

GARDEN

ELMARK

The Brand of Electricity

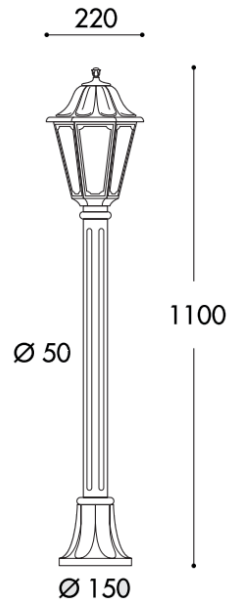

Catalogue number	Model	Lamp included	Power (W)	Whole fixture lumens (lm)	Color Temp. (K)	Colour body	Lamp holder
96120F/BL	Lantern floor post	yes	6	800	4000	Black	E27

Packing:

Catalogue number	Barcode	Packing/ Box (pcs)
96120WU/BL	3800131220424	1/18
96120P/BL	3800131220448	1/18
96120MF/BL	3800131220431	1/18
96120F/BL		1

TECHNICAL SPECIFICATION

GARDEN

ELMARK[®]

The Brand of Electricity



ELMARK
lighting

96120WU/BL



This luminaire is compatible with bulbs of the energy classes:

A⁺⁺

A⁺

A

B

C

D

E

}



874/2012

• 60598-1 • 60598-2-2 •

